

CONNECTEURS & ADAPTATEURS RF

retrouver ce produit sur www.bbeam.com

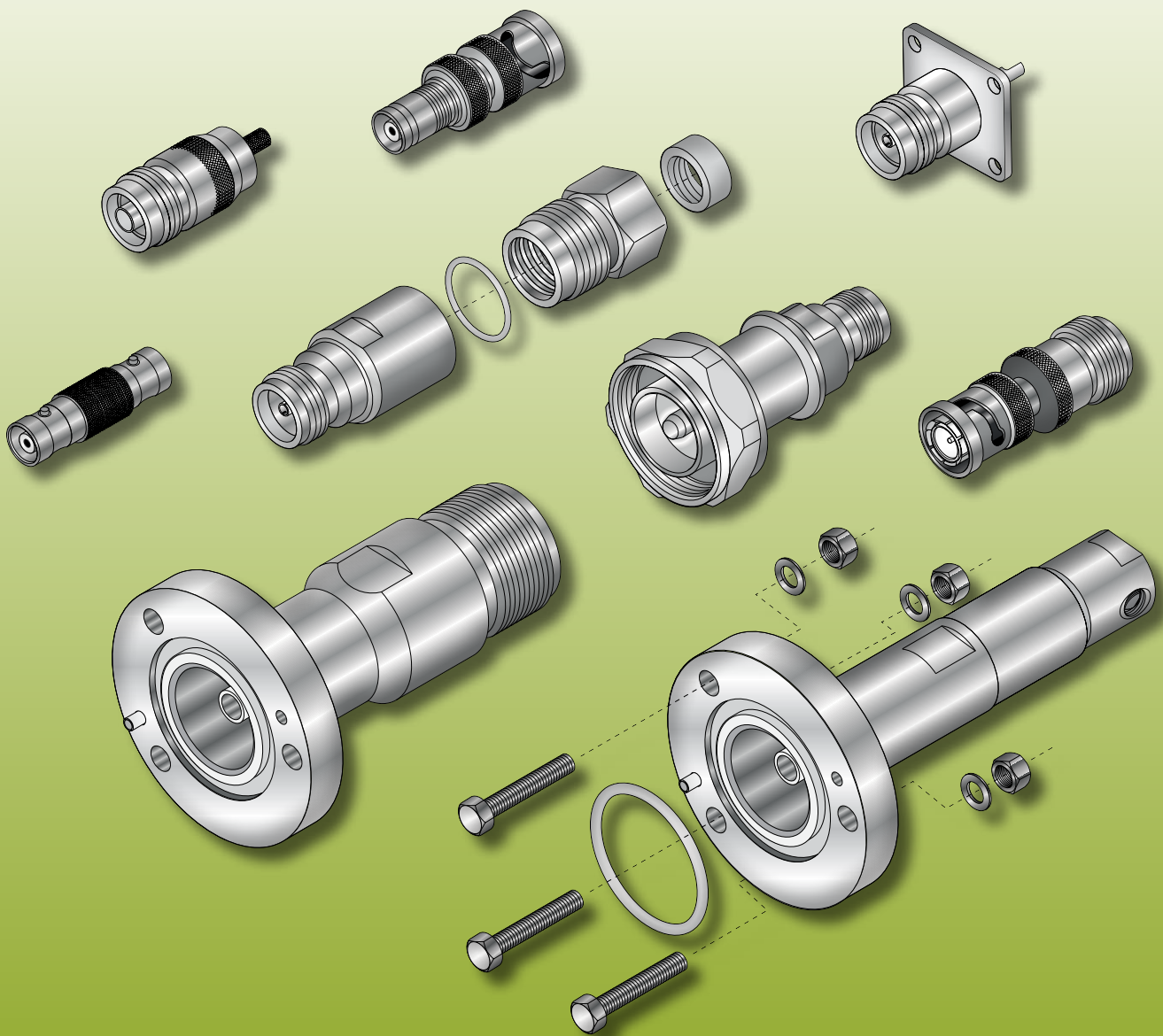

CONNECTEURS RF

CONNECTEURS RF - N

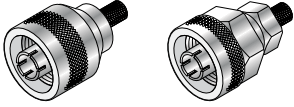
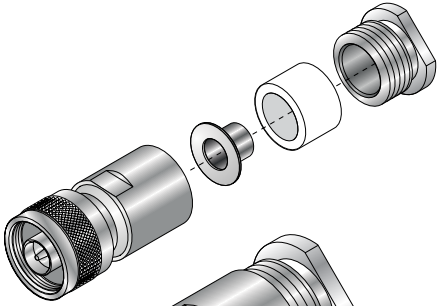
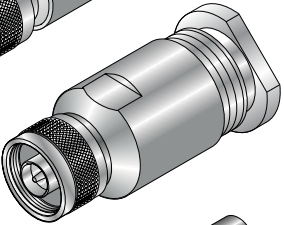
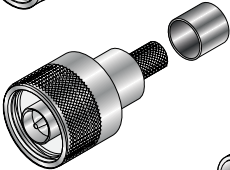
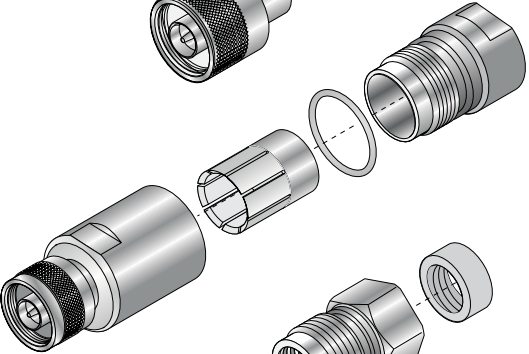
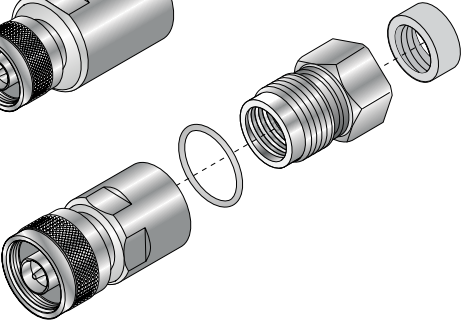
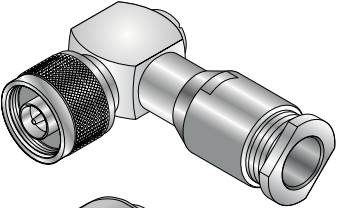
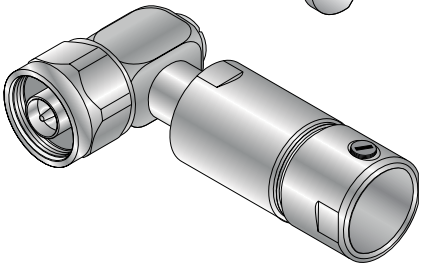
Modèle	Réf.	Entrée	Sortie	Type
	18001	N Mâle	RG58-303	à sertir
	18003	N Mâle	RG213	
	18013	N Mâle	RG217	
	18014	N Mâle	RG213	à sertir
	18016	N Mâle	RG58-303	à sertir
	18017	N Mâle	Hiflex 1/2"	
	18009	N Mâle	RG213	
	18012	N Mâle	Celflex 1/2"	

CONNECTEURS RF - N

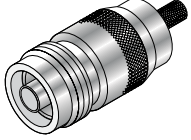
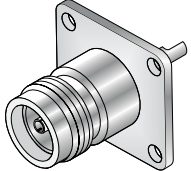
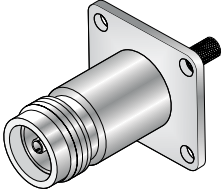
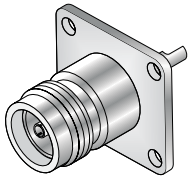
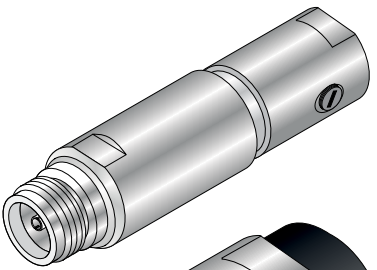
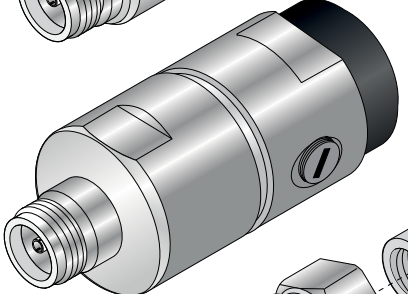
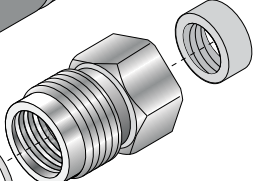
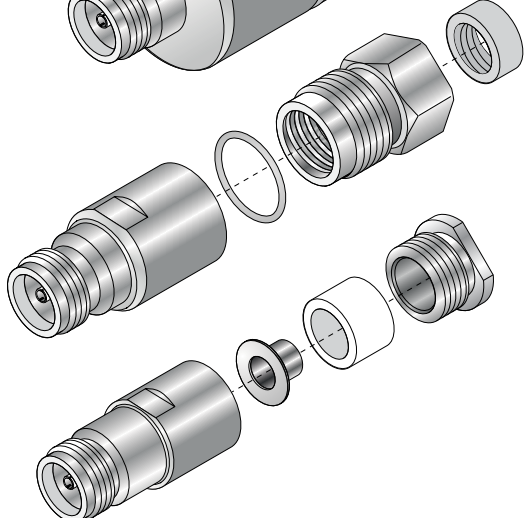
Modèle	Réf.	Entrée	Sortie	Type
	18002	N Femelle	RG58-303	à sertir
	18006	N Femelle (Châssis)	RG303	à sertir
	18007	N Femelle (Châssis)	Soquet	
	18015	N Femelle (Châssis)	Soquet PVC	
	18008	N Femelle	Celflex 1/2"	
	18011	N Femelle	Celflex 7/8"	
	18018	N Femelle	Hiflex 1/2"	
	18005	N Femelle	RG213	

CONNECTEURS RF - 7/16"

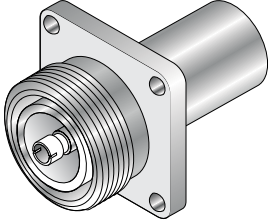
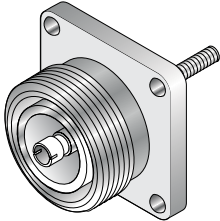
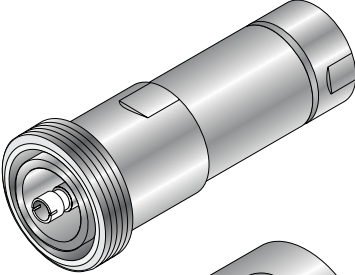
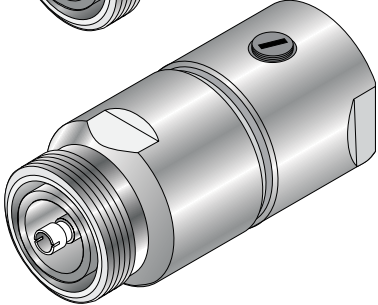
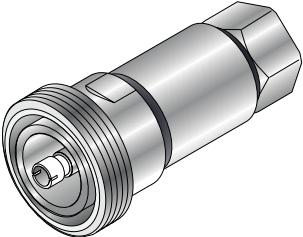
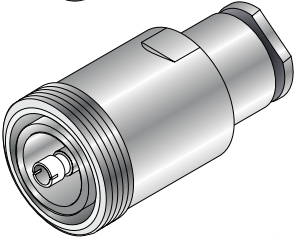
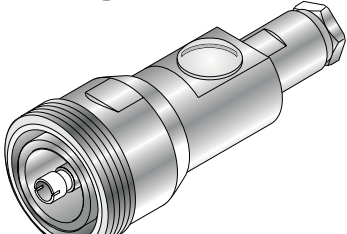
Modèle	Réf.	Entrée	Sortie	Type
	18028	7/16" Femelle (Châssis)	Soquet	
	18030	7/16" Femelle (Châssis)	Vis RG213	
	18025	7/16" Femelle	Celflex 1/2"	
	18027	7/16" Femelle	Celflex 7/8"	
	18035	7/16" Femelle	Hiflex 1/2"	
	18020	7/16" Femelle	RG213	
	18031	7/16" Femelle	RG303	

CONNECTEURS RF - 7/16"

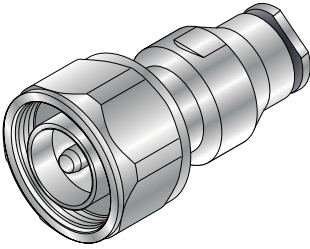
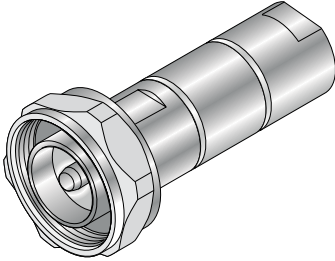
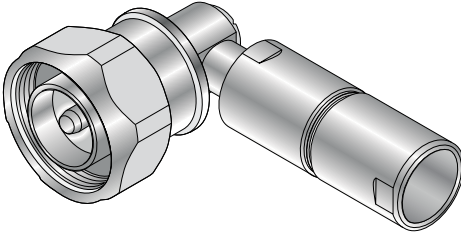
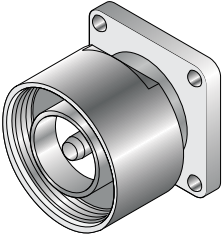
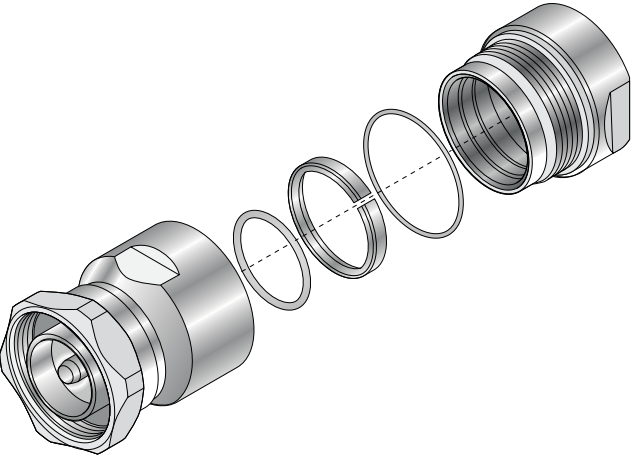
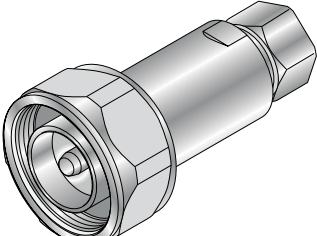
Modèle	Réf.	Entrée	Sortie	Type
	18019	7/16" Mâle	RG213	
	18023	7/16" Mâle	Celflex 1/2"	
	18024	7/16" Mâle 90°	Celflex 1/2"	
	18029	7/16" Mâle (Châssis)	Soquet	
	18032	7/16" Mâle	Celflex 7/8"	
	18034	7/16" Mâle	Hiflex 1/2"	

CONNECTEURS RF - EIA 7/8"

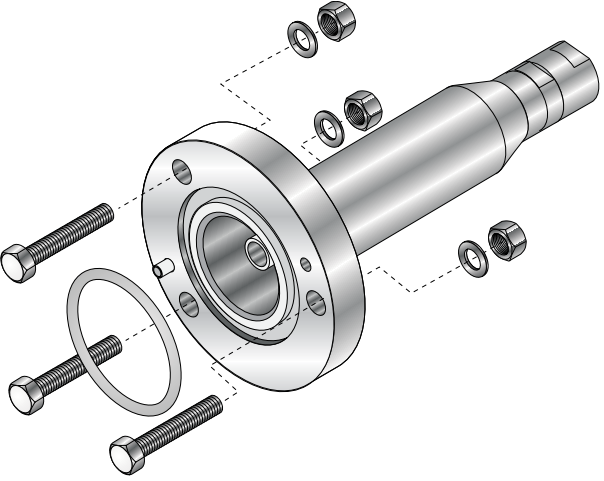
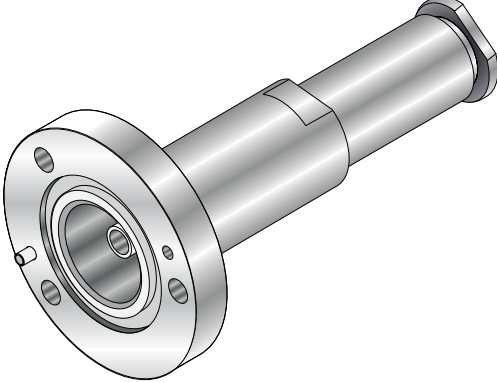
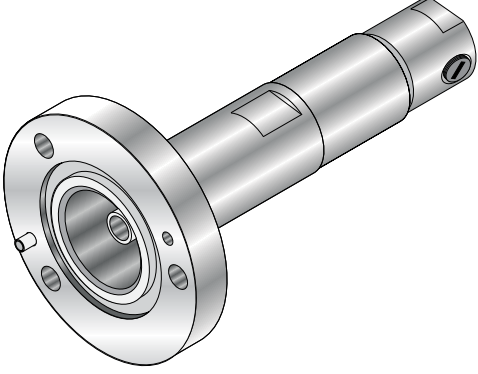
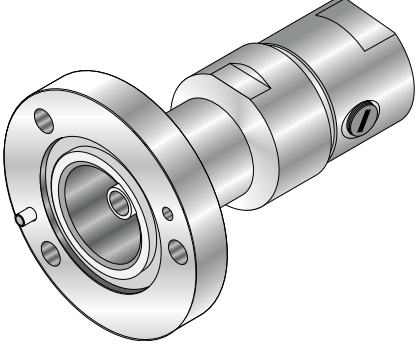
Modèle	Réf.	Entrée	Sortie	Type
	18039	EIA 7/8"	Hiflex 1/4"	
	18040	EIA 7/8"	RG213	
	18041	EIA 7/8"	Celflex 1/2"	
	18042	EIA 7/8"	Celflex 7/8"	

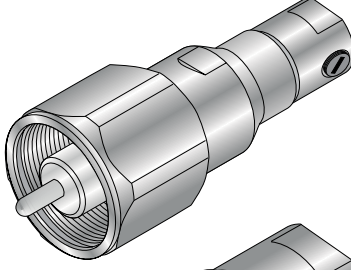
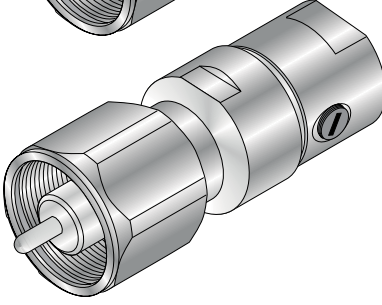
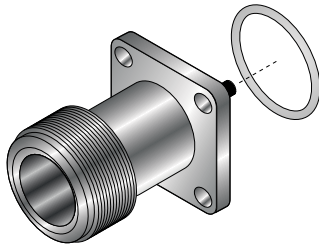

CONNECTEURS RF - LC

Modèle	Réf.	Entrée	Sortie	Type
	18036	LC Mâle	Celflex 1/2"	
	18037	LC Mâle	Celflex 7/8"	
	18038	LC Femelle (Châssis)	Soquet	

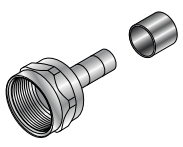
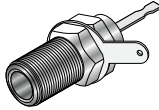
CONNECTEURS RF - F

Modèle	Réf.	Entrée	Sortie	Type
	18055	F Mâle	75 ohms	à visser
	18060	F Mâle	75 ohms	à sertir
	18057	F Femelle	Châssis	à visser

CONNECTEURS RF - PL

Modèle	Réf.	Entrée	Sortie	Type
	18021	PL Mâle	RG213	
	18022	PL Mâle	RG58	à visser



CONNECTEURS RF - TNC

Modèle	Réf.	Entrée	Sortie	Type
	18056	TNC	RG58	à sertir

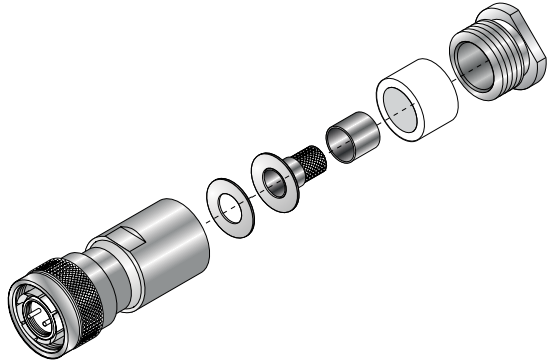
CONNECTEURS RF - Twinax

Modèle	Réf.	Entrée	Sortie	Type
	18054	Twinax	RG213	

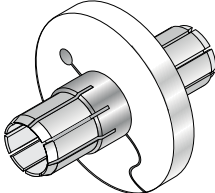
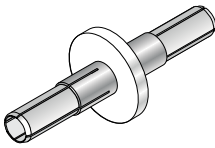
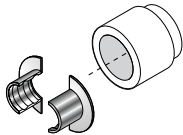

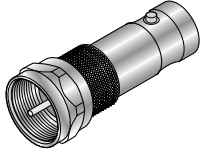
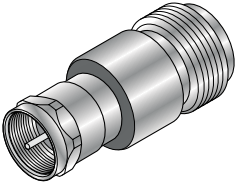
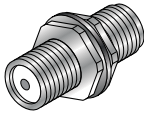
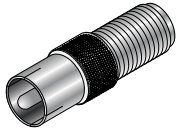
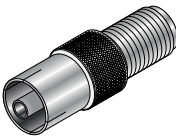
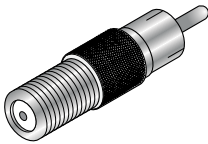

CONNECTEURS RF - Accessoires et Kits

Modèle	Réf.	Entrée	Sortie	Type
	18051	Inner pour EIA 1"5/8		
	18050	Inner pour EIA 7/8"		
	18052	Kit 1/4" rouge pour N RG		
	18053	Kit de réparation N RG		

ADAPTATEURS RF

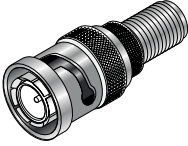
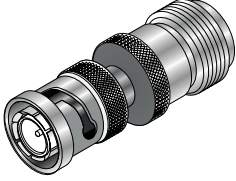
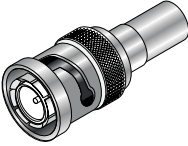
ADAPTATEURS RF - F				
Modèle	Réf.	Entrée	Sortie	Type
	20018	F Mâle	BNC Femelle	
	20038	F Mâle	N Femelle	
	20016	F Femelle	F Femelle	
	20019	F Femelle	PAL Mâle	
	20029	F Femelle	PAL Femelle	
	20041	F Femelle	RCA Mâle	

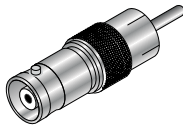
ADAPTATEURS RF - BNC

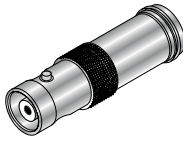
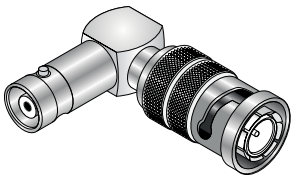
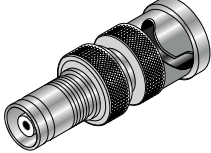
Modèle	Réf.	Entrée	Sortie	Type
	20014	BNC Mâle	F Femelle	
	20022	BNC Mâle	N Femelle	
	20025	BNC Mâle	RCA Femelle	
	20047	BNC Mâle	BNC Mâle	
	20023	BNC Femelle	RCA Mâle	
	20024	BNC Femelle	BNC Femelle	
	20042	BNC Femelle	F Mâle	à clipser
	20046	BNC Femelle	BNC Mâle 90°	
	20051	BNC Femelle	BNC Mâle	

ADAPTATEUR RF - PL

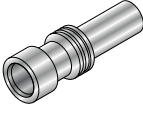
Modèle	Réf.	Entrée	Sortie	Type
	20001	PL	RG58	

ADAPTATEURS RF - LC

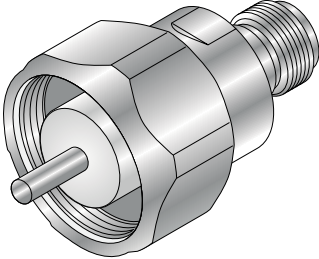
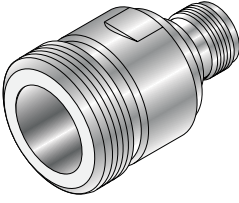
Modèle	Réf.	Entrée	Sortie	Type
	20005	LC Mâle	N Femelle	
	20006	LC Femelle	N Femelle	

ADAPTATEURS RF - 7/16

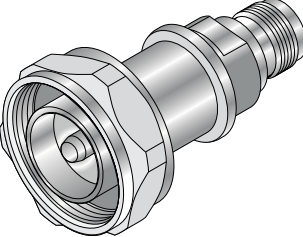
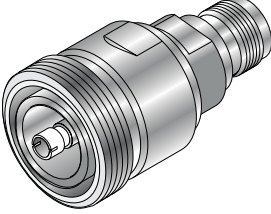
Modèle	Réf.	Entrée	Sortie	Type
	20007	7/16 Mâle	N Femelle	
	20008	7/16 Femelle	N Femelle	

ADAPTATEURS RF - EIA 7/8"

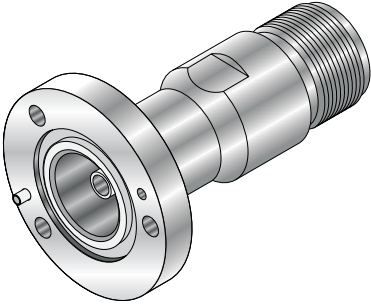
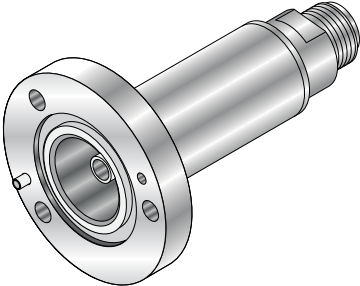
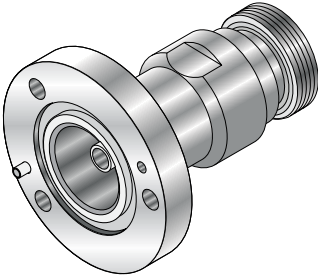
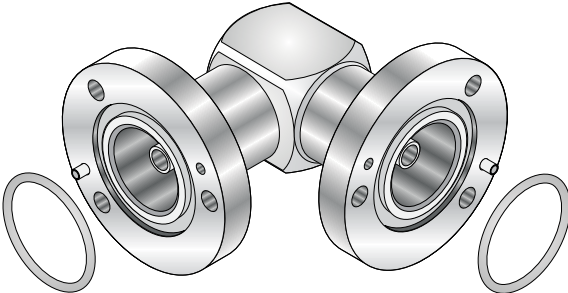
Modèle	Réf.	Entrée	Sortie	Type
	20011	EIA 7/8"	LC Femelle	
	20004	EIA 7/8"	N Femelle	
	20010	EIA 7/8"	7/16" Femelle	
	2015	EIA 7/8"	EIA 7/8" 90°	

ADAPTATEURS RF - EIA 7/8"

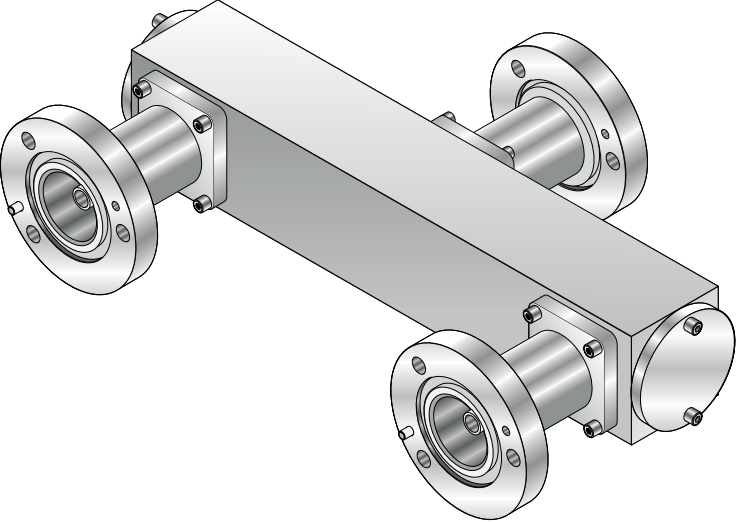
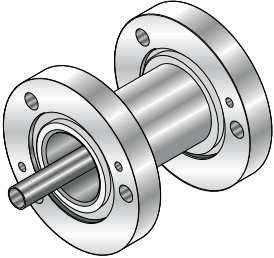
Modèle	Réf.	Entrée	Sortie	Type
	20003	EIA 7/8"	Ligne accord duplexeur EIA	
	20012	Manchon EIA 7/8" Mâle/ Femelle		

ADAPTATEURS RF - EIA 1"5/8

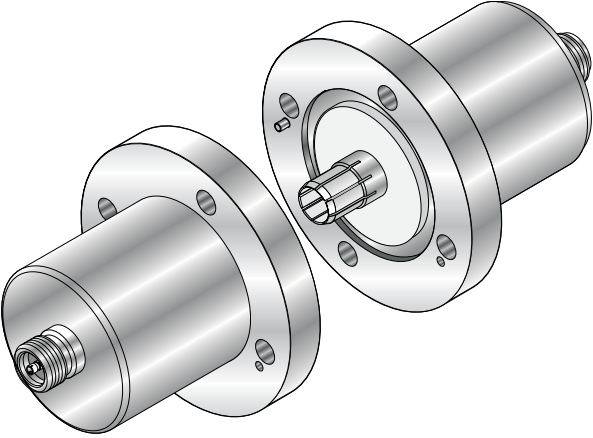
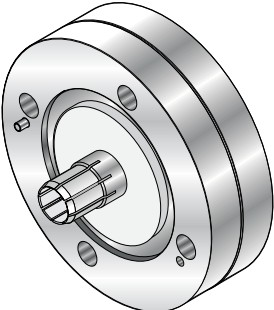
Modèle	Réf.	Entrée	Sortie	Type
	20013	EIA 1"5/8	N Femelle	
	20002	EIA 1"5/8	EIA 7/8"	

